

# FLEXITRAILER FT-HD-S

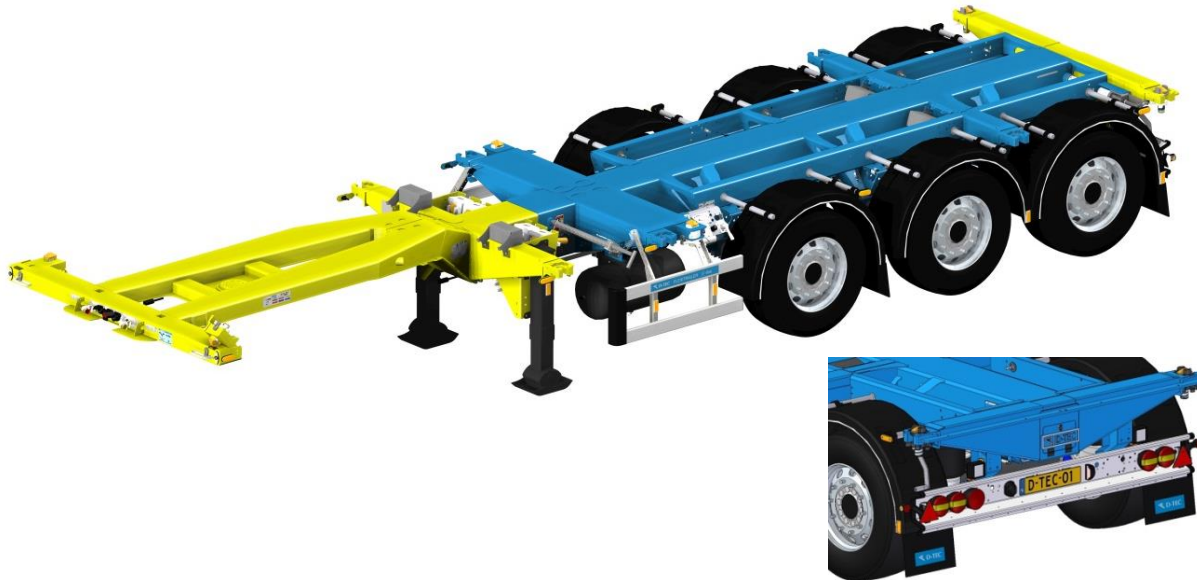

**Technische gegevens**

Geschikt voor

Schoteldruk  
 Maximale aslast per as  
 Totaal toegestane massa  
 Leeggewicht  
 Nuttig laadvermogen  
 Schotelhoogte  
 Chassishoogte  
 Elektrische aansluitingen

**Technische Daten**

Geeignet für

Sattellast  
 Max. Achslast per Achse  
 Gesamt zulässige Masse  
 Leergewicht  
 Nutzlast  
 Sattelhöhe  
 Chassishöhe  
 Elektrische Anschlüsse

**Technical data**

Suitable for

Kingpin weight  
 Maximal Axleload / axle  
 Gross trailer weight  
 Empty weight  
 Payload  
 Fifthwheel height  
 Chassisheight  
 Electrical connectors

**FT-HD-S**

20 ft rear  
 20 ft tank  
 20 ft central  
 30 ft  
 2x 20 ft  
 40 ft (HC)  
 45 ft  
 16.000 kg  
 9.000 kg  
 43.000 kg  
 4.800 kg  
 38.200 kg  
 1.110 mm  
 1.110 mm  
 2x 7-pin + 1x 15 pin

**OPTIES / OPTIONEN / OPTIONS**

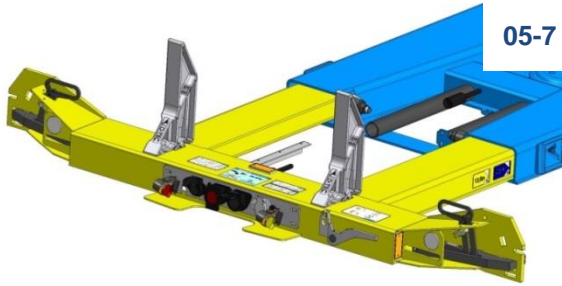

05-7



17-11



15-12

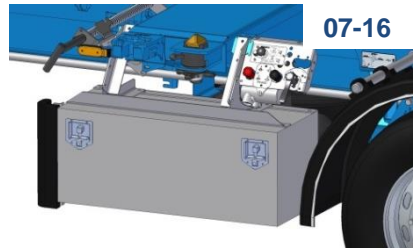

07-16

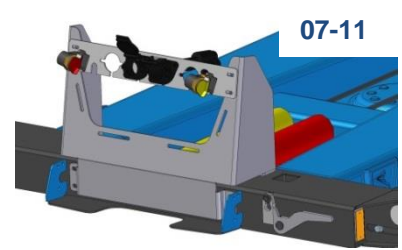

07-11



07-26

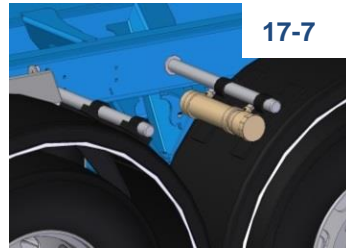

17-7

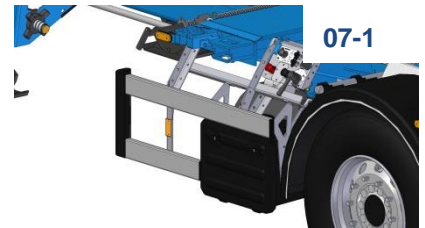

07-1

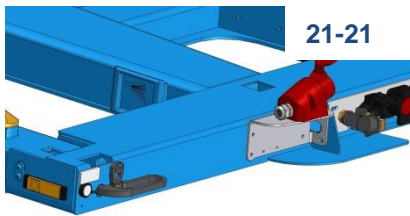

21-21



11-15

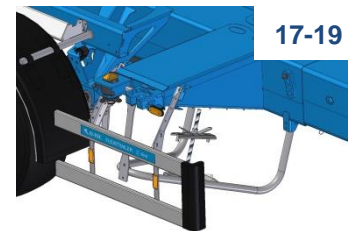

17-19

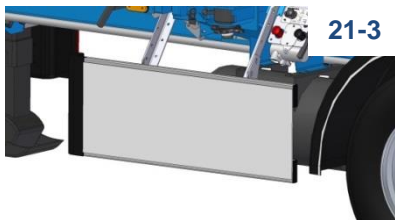

21-3



17-21



11-2-17



21-8



07-3

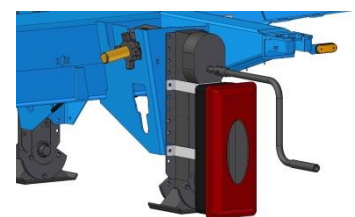

07-10

 <b>Basis opties</b>		 <b>Basis Optionen</b>		 <b>Basic options</b>	
11-4-15	Valx trommelremmen As 1 liftas manueel / automatisch	Valx Trommelbremsen Achse 1 Liftachse man. / automatisch	Valx drumbrakes Axle 1 liftaxle manual / automatic		
19-55	Bandenmaat 385/55R22,5	Reifengröße 385/55 R22,5	Tyresize 385/55 R22,5		
19-B	Banden keus D-TEC 1 laag 2K natlak RAL 5015 / 9005	Reifen nach Wahl D-TEC 1 Schicht 2K RAL 5015 / 9005	Tyremake D-TEC choice 1-Layer coating 2K RAL 5015 / 9005		
09-1-2	Bovenzijde schooperen	Oberseite spritzverzinkt	Topside schooping		
05-7	Flexilock voor 45' legaal	Flexilock für 45' legal	Flexilock for 45' legal		
21-5	2 Wielkeggen	2 Radkeile	2 Wheelwedges		
21-16	Containerstops	Containerstops	Containerstops		
<b>Comfort opties</b>		<b>Komfort Optionen</b>		<b>Comfort options</b>	
	VALX / Mercedes-Benz / SAF schijf	VALX / Mercedes-Benz / SAF Scheibe	VALX / Mercedes-Benz / SAF disc		
11-4-8	BPW trommelremmen	BPW Trommelbremsen	BPW drumbrakes		
11-2-17	laatste as na loop gestuurd As 1 aut. / handm. liftas, as 3 handm.	Letzte Achse nachlaufgelenkt A. 1 aut. / man. Liftachse, A. 3 man.	Last axle steeringaxle A. 1 aut./man. liftaxle, axle 3 manual		
11-15	ATO	ATO	ATO		
19-65	Bandenmaat 385/65R22,5. Continental HTR2 /	Reifengröße 385/65 R22,5 Goodyear LHT II / GT /	Tyresize 385/65 R22,5 Michelin XTE3		
19-7-3	Alcoa Durabright 6 alu velgen Reserwiel staal 385/65 of 55	Alcoa Durabright 6 alu Felgen Reserverad Stahlfelge 385/65 oder 55	Alcoa Durabright 6 alloy rims Sparewheel steel 385/65 or 55		
09-1-1	Volledig schooperen Standard Coating in RAL 3002,	Völlig spritzverzinkt RAL 5002, RAL 5010, RAL 5015,	Full schooping RAL 7016, RAL 7021, RAL 9005		
09-6-SP	sputen 2-laags 2K natlak naar keuze	Lackieren 2 Schicht 2K nach Wahl	2-Layer coating 2K customer choice		
09-4-3	naven + doppen sputen	Naben und Kappen lackiert	Hubs and caps painted		
15-12	6x ronde 3-kamer lampen, alles LED	6x Runde 3-Kammerleuchten LED	6 Round lights, LED		
05-17	Klapkokers ivm geen tunnel	Klappstützen wegen ohne Tunnel	Filling pieces due to no tunnel		
07-1	Kunststof gereedschapskist links.	Kunststoff Werkzeugkasten links	Plastic toolbox		
07-11	Verhoogde stekkerplaat	Erhöhte Anschlüsse vorne	Higher connectors at the front		
07-16	RVS gereedschapskist links	V2A Werkzeugkasten links / rechts	Stainless steel toolbox left / right		
07-26	Rolletjes onder achterkoker	Rollen unter Heckausschub	Bearings for easier cranking out		
07-3	Kingpenslothouder	Halter für Königszapfenverriegelung	Holder for kingpinlock		
07-5	Gevaarlijke stoffen bord	Gefahrgutschild	ADR sign at the rear, orange		
17-11	RVS lekbak	V2A Auffangwanne	Stainless steel drip tray		
17-19	Reserwiel drager	Reserveradträger	Sparewheel carrier		
17-7	Documenten koker uit plastic.	Dokubox Kunststoff	Document tube		
17-21	Brede spatlap onder de bumper	Breiter Schmutzfänger	Mudflap under bumper		
21-10	Houder zonder 6 kg brandblusser	Halter ohne 6kg Feuerlöscher	Holder without 6kg fire extinguisher		
21-21	Vorbereiding genset	Vorbereitung Genset	Genset preparation		
21-3	Zijbeplating witte trespa	Seitl. Unterfahrschutz Trespa, weiß	Trespa sidefenders, white		
21-8	Kingpinslot	Königszapfenverriegelung	Kingpinlock		
03-4-A	ADR-fabrikantverklaring	ADR Herstellerbestätigung	ADR Manufacturer certificate		
25-NS-2	LZV uitgevoerd en gekeurd	nur für NL	only NL		
17-2	ADR/VLG uitvoering incl certificaat	nur für NL	only NL		



